

NPHS FRIDAY MESSAGE

THE OFFICIAL NEWSLETTER FOR FAMILIES

March 25, 2022

Dear New Paltz High School Families,

Here is a small list of Daily Affirmations that can impact our being.

All the best to you,
Samuelle

CONTENT

A Message from Principal Simms

Important Dates

Around NPHS

“I AM VALUABLE”
“I AM ABUNDANT”
“I AM POWERFUL”
“I AM OPTIMISTIC”
“I AM MAGNIFICENT”
“I AM SUCCESSFUL”
“I AM PROSPEROUS”
“I AM COURAGEOUS”

Important Dates

March 31st to April 2nd- High School Musical
April 11th-15th - Spring Recess

Around NPHS

New Paltz High School's PIGLETS class is hosting a needs drive, called FUN 2 FEED in support of Family of New Paltz. PIGLETS has dedicated time to researching food insecurity and have identified a need to support our local organizations. We will be organizing a series of pay to play games and a raffle during all four lunches on April 7th. Please consider bringing cash to school on April 7th to participate in some games and support a local cause! Games will likely cost \$1-3!



PARTICIPATION IN GOVERNMENT

This week the Participation in Government classes participated in a Supreme Court Simulation. They spent previous classes learning about how students are protected by the First Amendment and after getting assigned roles and conducting research, a case was presented to our class court for a decision. All students did a great job! - Ms. Kiley



BAND

NEW PALTZ HS BAND PRESENTS

JAZZ CABARET

TUESDAY, APRIL 5TH
6:30 PM

NP

\$3
SUGGESTED DONATION

FEATURING:

BAND AWARDS 2022

NPHS JAZZ BAND

STUDENT ENSEMBLES

FREE POPCORN!

NPHS Jazz Band invites all NPHS students and families to the Jazz Cabaret! The cafeteria will be transformed to a live music venue for the event on Tuesday, April 5th at 6:30 pm.

Band Students will perform with the Jazz Band and also with several student-led bands. Free popcorn will be provided to all attendees, and sodas and water will be available for purchase.

ATHLETICS

Congratulations to Jena Russo for being selected to the BCANY-Section IX Girls' Chapter All-Section "TOP 50" Team for the 2021-2022 season. Jena is among just 50 basketball players from all classes in Section IX to be voted onto this team by the coaches in Section IX. Congratulations Jena!



LIFE SKILLS

This week in Life Skills, we finished up learning about the Human Body Systems. We wrapped up by mapping out our arteries and veins using Play Doh. Then we used Play Doh and toothpicks to see how our skeletons help support our bodies. We're moving into learning about our five senses and will be using our senses to learn more about what is around us and how our senses help us experience more.- Ms. Dudek

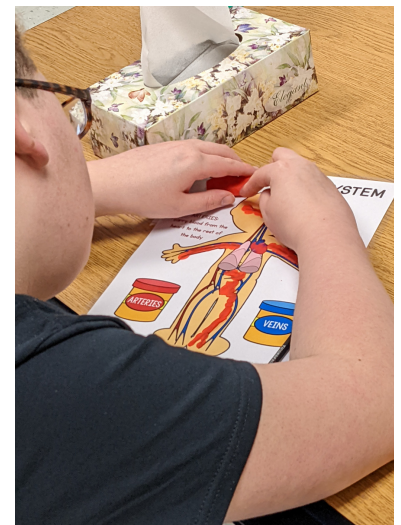
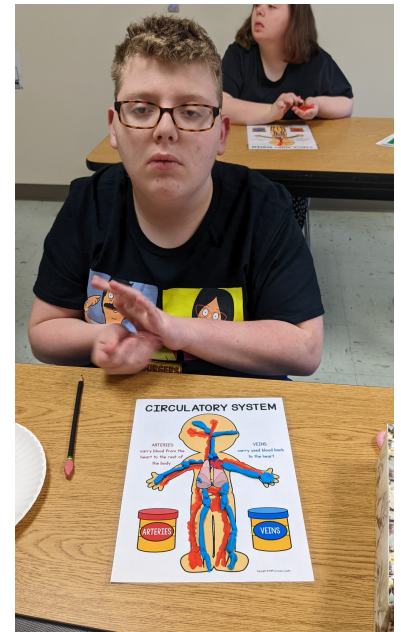
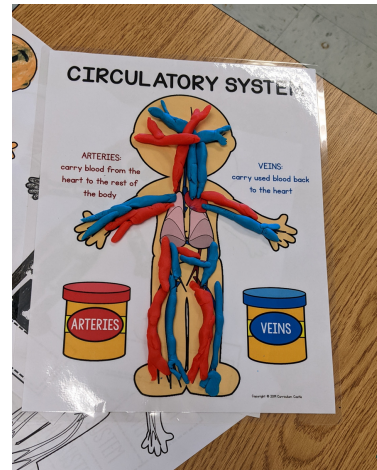

HS MUSICAL

THE NPHS MUSICAL, THE THEORY OF RELATIVITY, WILL BE PERFORMED NEXT WEEKEND! PERFORMANCES WILL BE IN THE HS AUDITORIUM ON:
THURSDAY, 3/31 AT 7:30PM
FRIDAY, 4/1 AT 7:30PM
SATURDAY, 4/2 AT 2:00PM
SATURDAY, 4/2 AT 7:30PM
TICKETS COST \$15 FOR ADULTS, AND \$10 FOR STUDENTS/SENIOR CITIZENS.
ALL TICKETS FOR THE SATURDAY MATINEE PERFORMANCE COST \$10.

TICKETS CAN BE PURCHASED AHEAD OF TIME USING THIS LINK: [HTTPS://WWW.SHOWTIX4U.COM/EVENT-DETAILS/62919](https://www.showtix4u.com/event-details/62919)
SEATS ARE ASSIGNED, SO YOU HAVE THE OPPORTUNITY TO CHOOSE YOUR OWN SEAT IF YOU PURCHASE AHEAD OF TIME. YOU CAN ALSO PURCHASE AT THE DOOR BEFORE ANY OF THE PERFORMANCES. ONE SEAT WILL AUTOMATICALLY BE BLOCKED OFF ON EITHER SIDE OF YOUR PARTY TO ALLOW FOR SOCIAL DISTANCING. MASKS ARE OPTIONAL.



MATHLETES

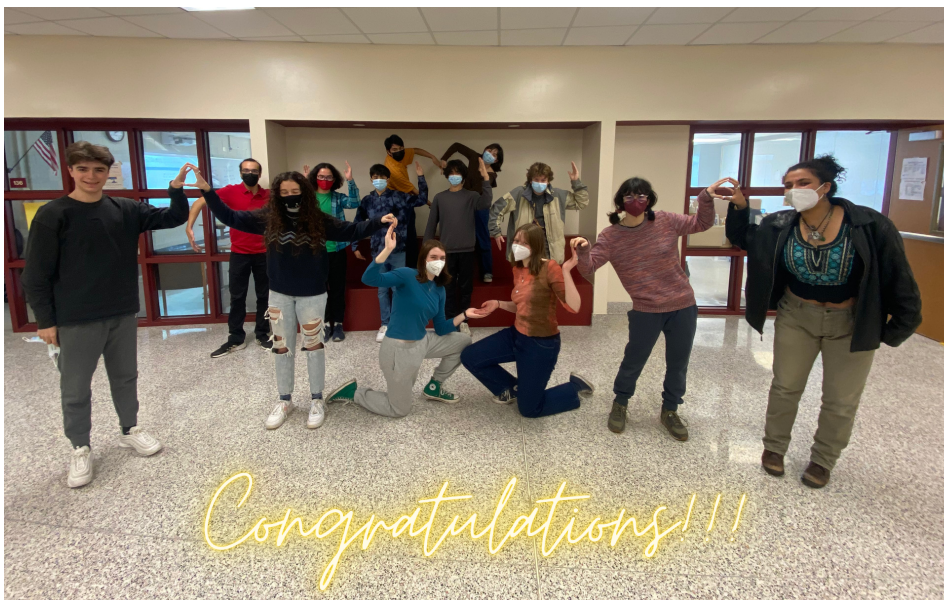

Our Mathletes A team came in 2nd place in Sectionals last week! We had some tough competition and had to win a tiebreaker to claim our second place finish. Bravo to all the A team members - Bebe Cosgrove, Mason Eyler, Max Hawkins, Caleb Lai, Sophia Loyer, and Sergio Mercado - and to all the Mathletes- Ms. Stewart.

ART

Here are final cuts/screenings for the "Laser Project" stay tuned for some amazing student productions next week!- Mr. Woods

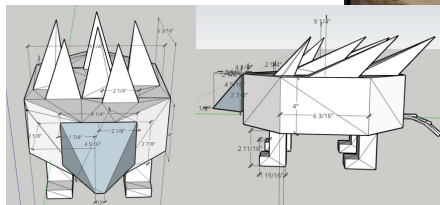
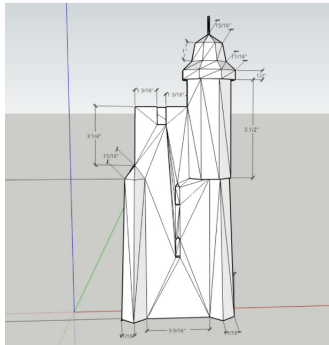
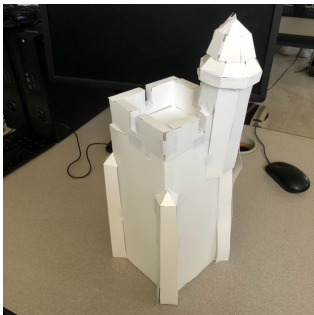
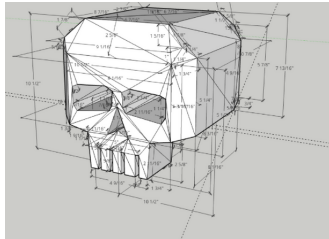
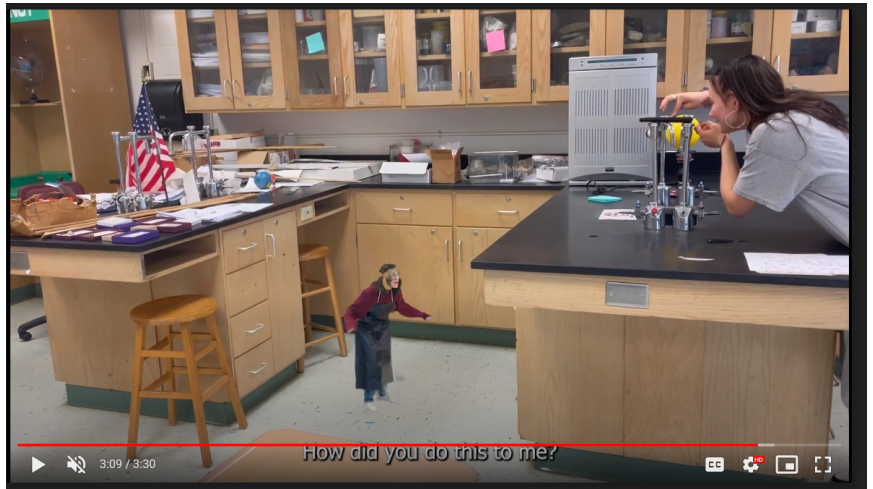
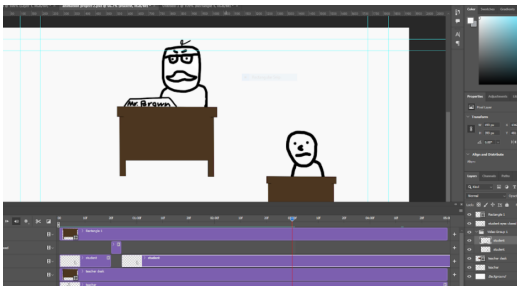

CARING, CONNECTING, AND MAKING A DIFFERENCE